



Mitigeur	Mesures	Code	Verre	Profils Prix
			1	D
		C	Transparent	Blanc

STANDARD

Finition p. 492

FINITION: Mitigeur Mécanique ou thermostatique, Douchette

MÉCANIQUE	90x90	202 H	MEDG90M-		
TERMOSTATIQUE	90x90	202 H	MEDG90T-		

HYDROMASSAGE

Finition p. 492

FINITION: Mitigeur Mécanique ou thermostatique, Douchette, Hydromassage vertical

MÉCANIQUE	90x90	202 H	MEDG90M1-		
TERMOSTATIQUE	90x90	202 H	MEDG90T1-		

Exemple de composition du code:

MEDG90M-1D = **MEDG90M-** + **1** + **D**



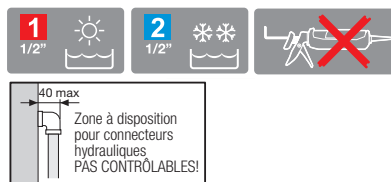
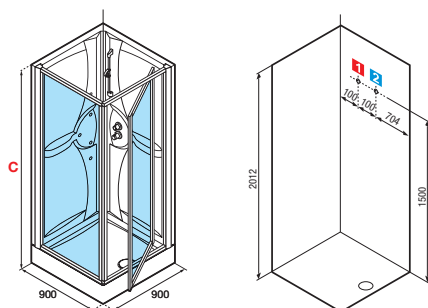
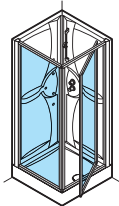
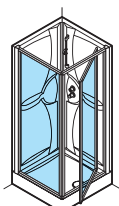



Délai de livraison indicatif : 28 jours ouvrés



CARACTERISTIQUES HYDRAULIQUES

- Pression dynamique optimale 2÷5 bar
- Eau chaude 1/2"
- Eau froide 1/2"
- Raccordement évacuation Ø 40 mm

FINITIONS

	Versions	
	STANDARD	HYDROMASSAGE
	●	
	●	
		●
		●
	●	●
		●

FINITION PROFILES

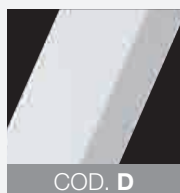

COD. D

blanc

VERRE

(European Standards UNI EN 14428)

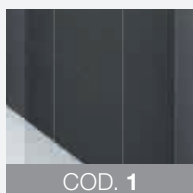

COD. 1

transparent
3 mm



TRAITEMENT

ACS ATTESTATION
DE CONFORMITÉ
SANITAIRE

Toutes les robinetteries Novellini et Elysium
sont conformes à l'attestation de conformité sanitaire.