

# YOUNG 2.0

Design exclusif, confort d'accès, portes pivotantes et repliables, poignée métallique ergonomique, profilés et charnières de haute qualité, mécanisme relevable à l'ouverture vers l'extérieur et vers l'intérieur.

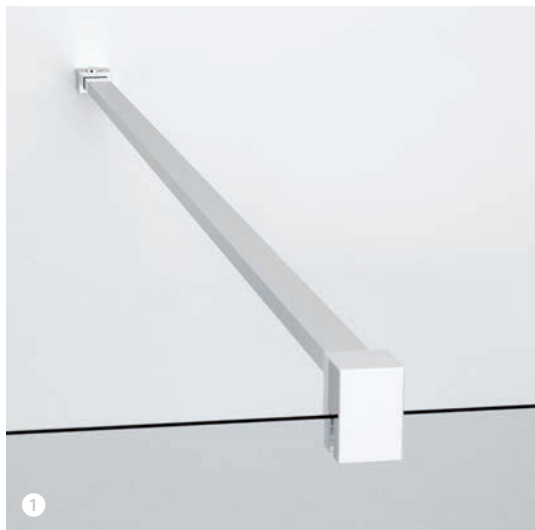

- ① Nouvelle barre de soutien. ② Poignée métallique chrome.  
③ Charnières relevables, porte réversible. ④ Ouverture intérieure extérieure..

## TRAITEMENT



**TRAITEMENT ANTI-GOUTTES**  
Cristal toujours brillant, facile à nettoyer. Empêche le dépôt du calcaire et des bactéries.  
**Seulement le verre transparent.**



**PVD FINITION CHROME ET GOLD**  
Sans aucune émission nocive.  
Anticalcaire, Résistant aux bactéries,  
Ecologique. Aspect brillant durable.

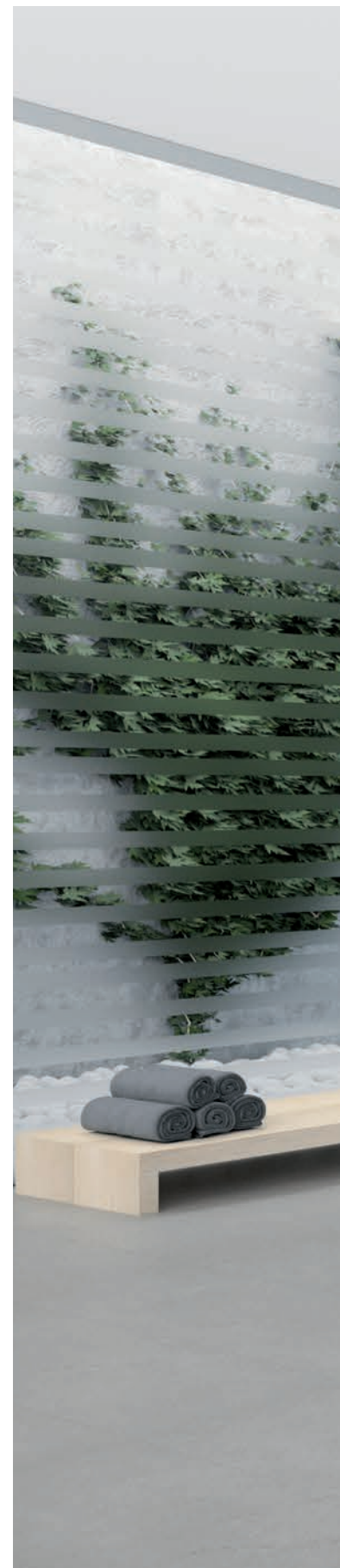

# YOUNG 2.0 1B

## PORTE PIVOTANTE

en niche ou en union avec panneaux fixes latéraux Young 2.0 F1B. Barre de seuil livrée en série.

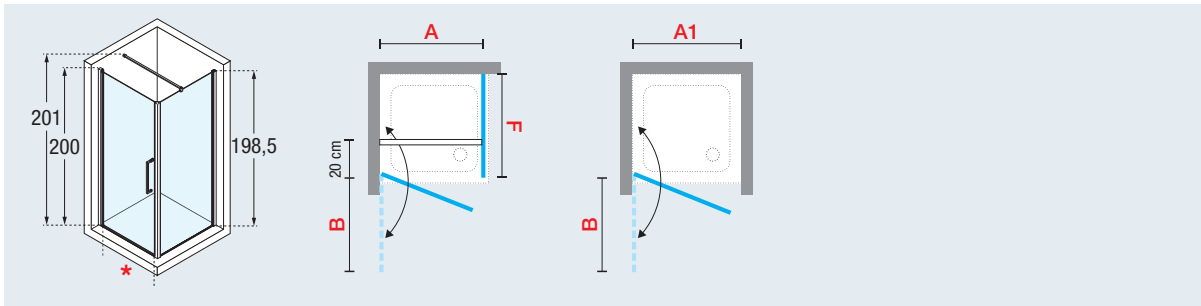

Mesures				Code	Choix Verre				Choix profilés et prix			
Mesure réelle de la paroi de douche		Passage	Encombrement extérieur de la porte		1	2	4	72	D	B	K	O
Avec paroi fixe	En niche											

### PORTE

A	A1	*	B	Code
58 ↔ 62	57 ↔ 61	47	48	<b>Y2 1B 57-</b>
68 ↔ 72	67 ↔ 71	57	58	<b>Y2 1B 67-</b>
73 ↔ 77	72 ↔ 76	62	63	<b>Y2 1B 72-</b>
78 ↔ 82	77 ↔ 81	67	68	<b>Y2 1B 77-</b>
88 ↔ 92	87 ↔ 91	77	78	<b>Y2 1B 87-</b>
98 ↔ 102	97 ↔ 101	87	88	<b>Y2 1B 97-</b>

H 140 ↓ 200 L 57 ↔ 99 SPECIAL **Y2 1B SP**

Transparent	Aqua	Satin	Victoriana or	Blanc	Silver	Chrome	Or
●							
●							
●							
●							

### PAROI FIXE

F	Code
57 ↔ 59	<b>Y2 F1B 57-</b>
59 ↔ 61	<b>Y2 F1B 59-</b>
65 ↔ 67	<b>Y2 F1B 65-</b>
67 ↔ 69	<b>Y2 F1B 67-</b>
69 ↔ 71	<b>Y2 F1B 69-</b>
73 ↔ 75	<b>Y2 F1B 73-</b>
75 ↔ 77	<b>Y2 F1B 75-</b>
77 ↔ 79	<b>Y2 F1B 77-</b>
79 ↔ 81	<b>Y2 F1B 79-</b>
85 ↔ 87	<b>Y2 F1B 85-</b>
87 ↔ 89	<b>Y2 F1B 87-</b>
89 ↔ 91	<b>Y2 F1B 89-</b>
95 ↔ 97	<b>Y2 F1B 95-</b>
97 ↔ 99	<b>Y2 F1B 97-</b>
99 ↔ 101	<b>Y2 F1B 99-</b>
117 ↔ 119	<b>Y2 F1B 117-</b>
119 ↔ 121	<b>Y2 F1B 119-</b>

✓ H 140 ↓ 200 L 20 ↔ 120 SPECIAL **Y2 F1B SP**

Transparent	Aqua	Satin	Victoriana or	Blanc	Silver	Chrome	Or
●							
●							
●							
●							
●							

EXEMPLE DE COMPOSITION DU CODE:

Y21B57-1D = Y21B57- + 1 + D

✓ Le fixe spécial doit être commandé avec la même hauteur que la porte

● Délai de livraison indicatif: 7 jours ouvrés





200 cm



6 mm



porte 4 cm  
paroi fixe  
2 cm



p. 75



L'OUVERTURE DE  
L'INTERNE-EXTERNE



## OPTION



### Barre de renfort d'angle

Mesures	Code	Prix	
		Chrome K	Or O
15 cm	<b>R80LOU150-</b>		
25 cm	<b>R80LOU250-</b>		
35 cm	<b>R80LOU350-</b>		
45 cm	<b>R80LOU450-</b>		

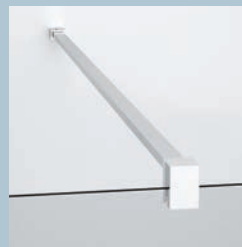

### Barre de renfort 150 cm

Finition	Code	Prix
Blanc	<b>R80Y215-D</b>	
Silver	<b>R80Y215-B</b>	
Chrome	<b>R80Y215-K</b>	
Or	<b>R80Y215-O</b>	



### Kit barre modulable

- 1 barre orientable de 100 cm (recoupable)
- 1 attache murale
- 1 pince de fixation au verre

Finition	Code	Prix
Blanc	<b>R80KUOR100-D</b>	
Silver	<b>R80KUOR100-B</b>	
Chrome	<b>R80KUOR100-K</b>	



### Kit barre "T"

barre de renfort 150 cm à combiner avec la barre en dotation pour montage en T

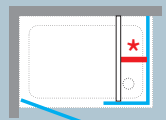

Finition	Code	Prix
Blanc	<b>R80Y215T-D</b>	
Silver	<b>R80Y215T-B</b>	
Chrome	<b>R80Y215T-K</b>	
Or	<b>R80Y215T-O</b>	

# DONNÉES TECHNIQUES

## VERRE 6 mm (European standards UNI EN 14428)

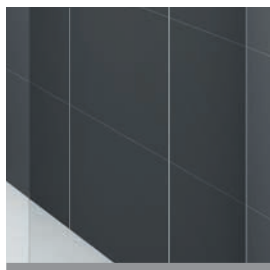

Transparent  
COD. 1



Aqua  
COD. 2



Satin  
COD. 4

## SÉRIGRAPHIE

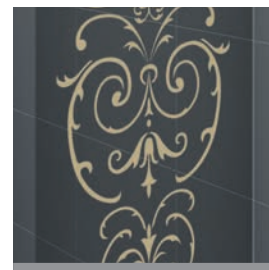

Victoriana or  
(Vernis doré)  
COD. 72

(seulement pour: 2G, G+F,  
1B, R2 LUX)

## FINITION PROFILÉS



Blanc  
COD. D



Silver  
COD. B



Chrome  
COD. K

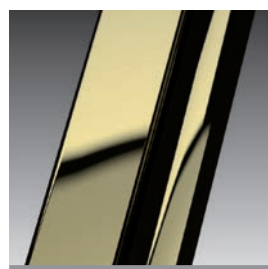

Or  
COD. O



(seulement pour: 2G, G+F, 2A,  
2B, F2B, G+F in linea, 1B, F1B,  
A, R, R2, R1 SWIM, R2 LUX)

## POIGNÉES



Poignée métallique  
chrome.  
**entraxe 384mm**

## COMMENT RELEVÉ LES MESURES

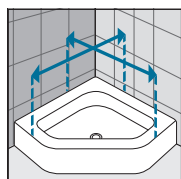
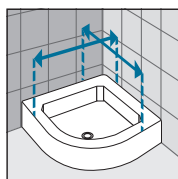
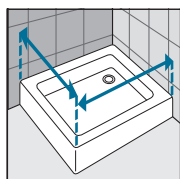

Prendre les mesures du mur au bord extérieur du receveur de douche. Relever les mesures après la pose du carrelage. Pour les montages en angle, il faut prévoir que la mesure réelle correspond à la mesure d'encombrement extérieur avec le profilé mural de la paroi en retour. Ceci doit être pris en compte impérativement pour les receveurs carrelés (pose à l'italienne ou receveur sans plage).

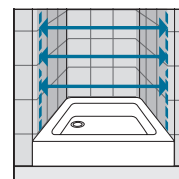

Prendre les mesures d'un mur à l'autre, en bas, en haut et au milieu et choisir la mesure inférieure. Relever les mesures après la pose du carrelage.

## CÔTES DES PROFILÉS MURAUX ET DE COMPENSATION

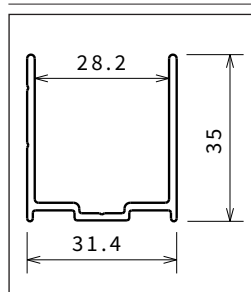

### a partir du mur

hauteur	Finition	Code
198,4 cm	Blanc	<b>P01BNMOBST-A</b>
	Silver	<b>P01BNMOBST-B</b>
	Chrome	<b>P01BNMOBST-K</b>
	Or	<b>P01BNMOBST-O</b>
200 cm	Blanc	<b>P01BNMOAST-A</b>
	Silver	<b>P01BNMOAST-B</b>
	Chrome	<b>P01BNMOAST-K</b>
	Or	<b>P01BNMOAST-O</b>

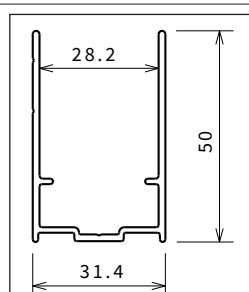

### compensation

hauteur	Finition	Code
198,4 cm	Blanc	<b>P05Y2ST-A</b>
	Silver	<b>P05Y2ST-B</b>
	Chrome	<b>P05Y2ST-K</b>
	Or	<b>P05Y2ST-O</b>
200 cm	Blanc	<b>P05Y2ST2-A</b>
	Silver	<b>P05Y2ST2-B</b>
	Chrome	<b>P05Y2ST2-K</b>
	Or	<b>P05Y2ST2-O</b>

Pour plus  
d'informations  
sur les profilés,  
voir page 330-335